

# Instrucciones para Papel Picado

## Se Necesita

papel chino (tissue paper)  
tijeras (scissors)  
cordón (string)  
cinta adhesiva (tape)

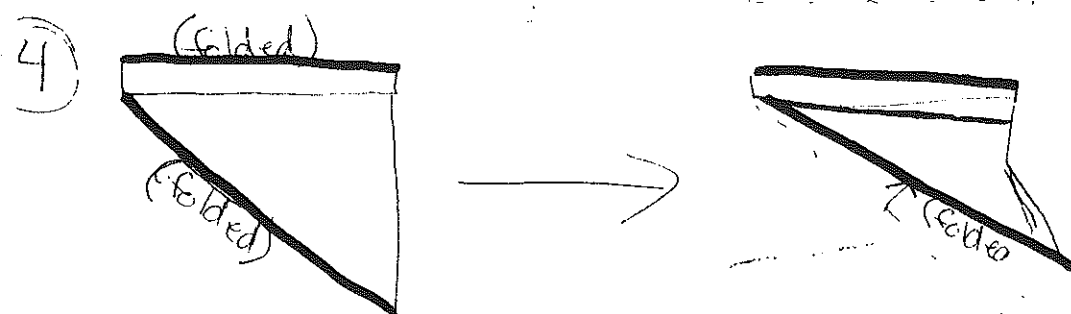

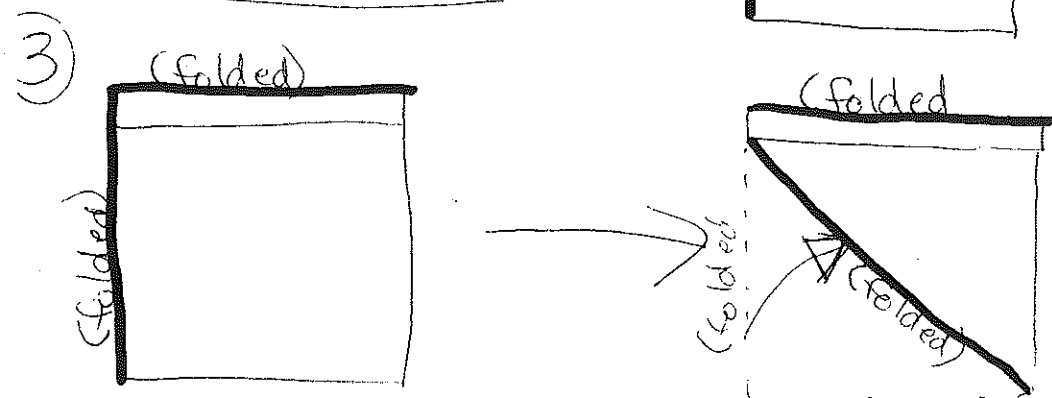
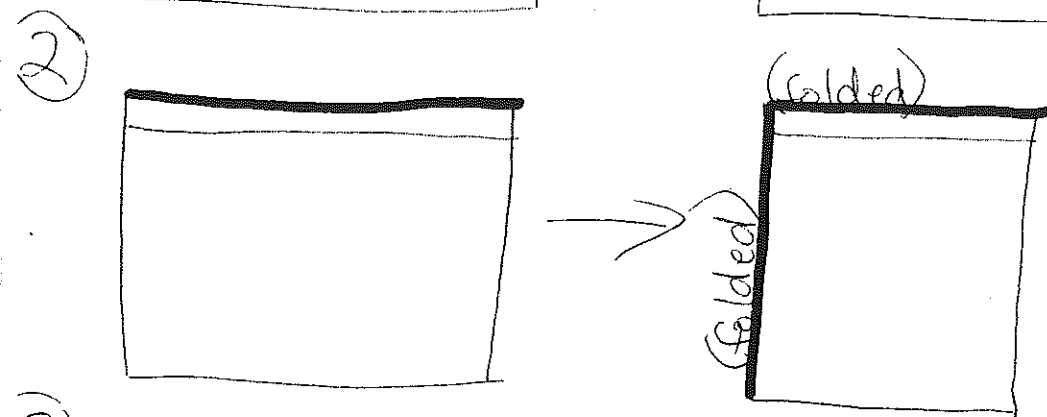
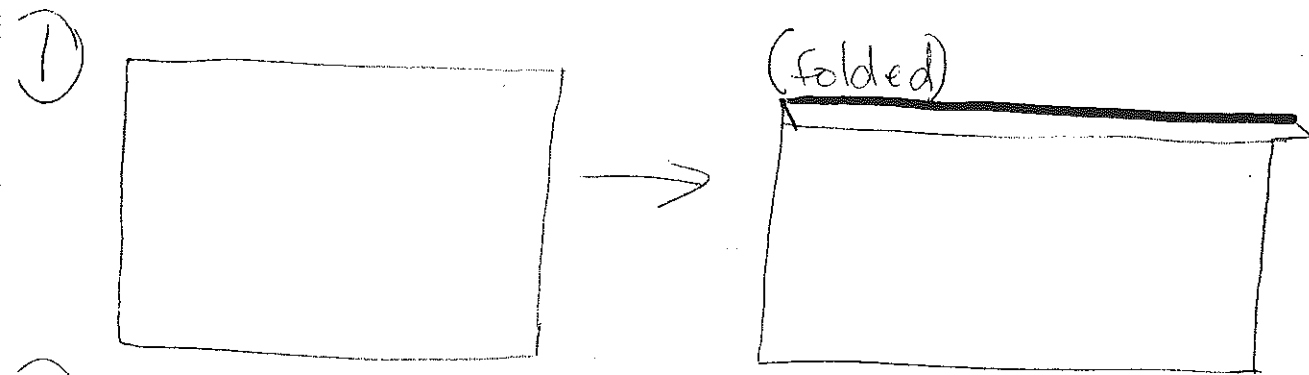
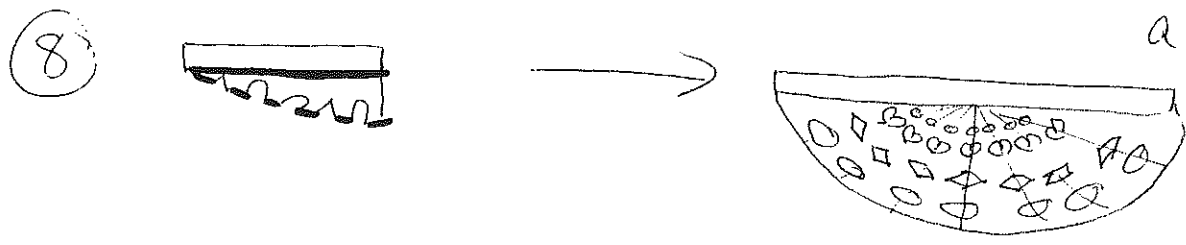
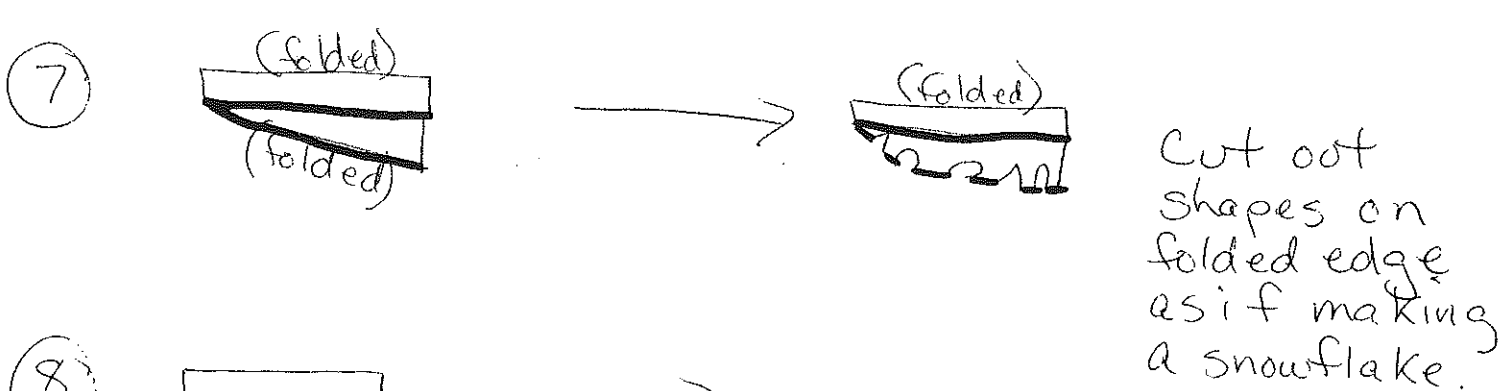
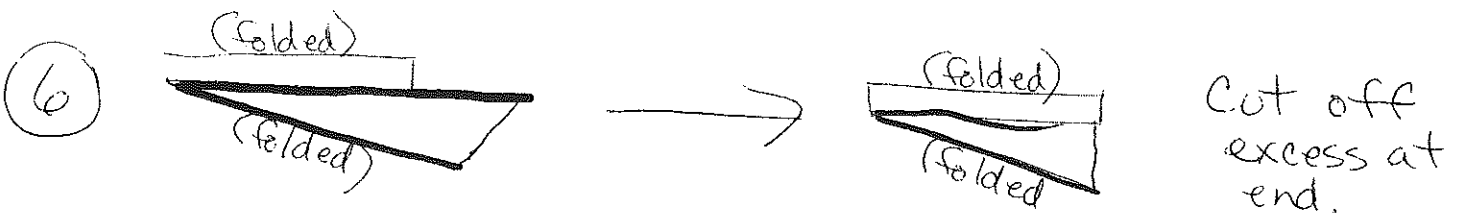

⑨ Open top fold and place string along the crease. Tape paper back in place, especially at the ends. Hang up alone or string several together.

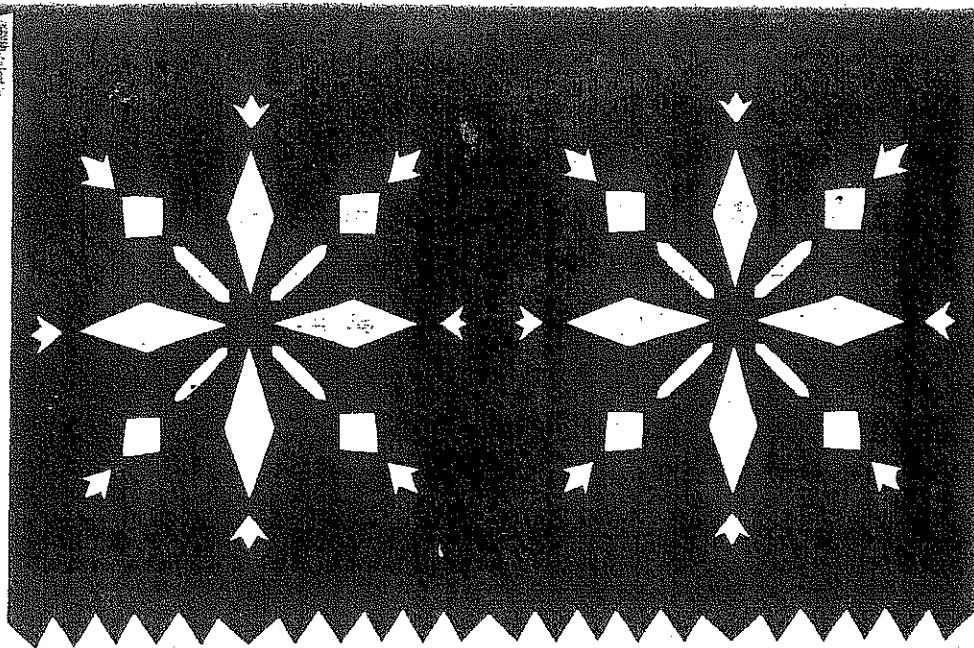

## TWINKLING STARS

---

My name for this papel picado project is Twinkling Stars, but the design you create might remind you of eight-petaled flowers. It is easy to make this right after the Four Cardinal Points because it repeats the first five steps of that project.

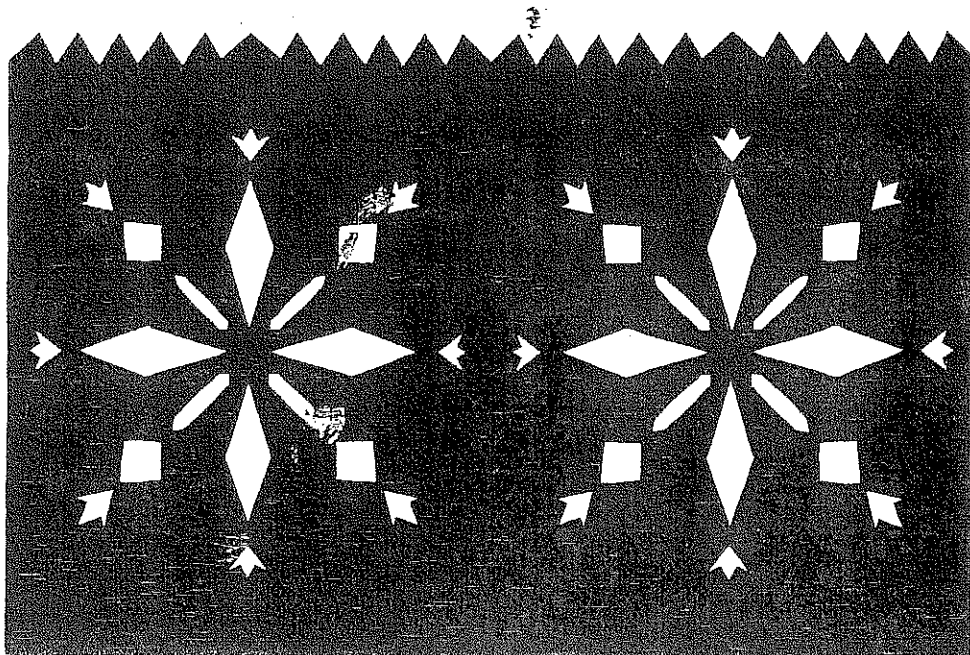



To make the string fold, fold up about 1 inch at the bottom of the paper.

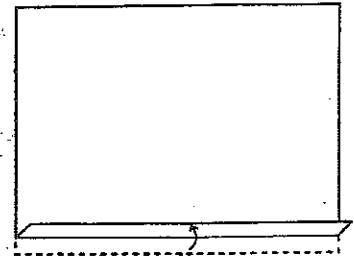

Rotate the paper so the string fold is at the top. Remember to keep the string fold at the top and make sure you can always see it—you don't want to cut it accidentally with your scissors. The cutout will be much stronger if the string fold is not cut.

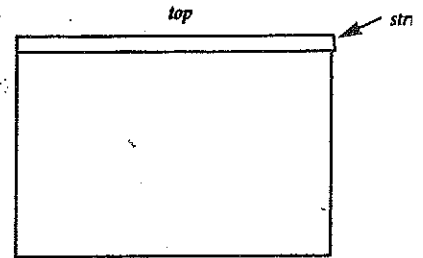

Fold the paper back in half, keeping the string fold on the outside of the paper. You don't need to match the corners. Just make sure that the side edges are even.

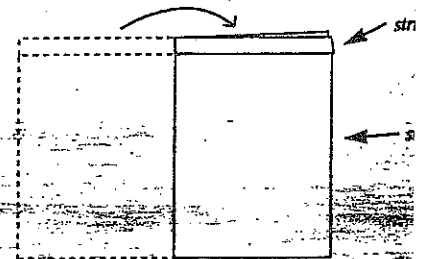

Fold the paper back in half again, placing the center fold along the side edges.

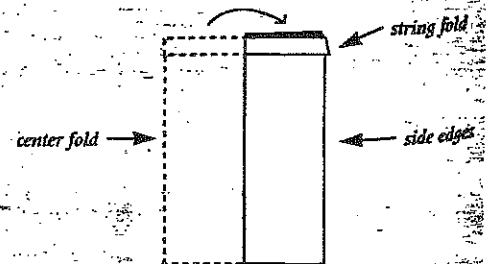

Fold the paper in half horizontally by bringing the bottom edge up to the string fold. You don't want to cover the flap of the string fold.

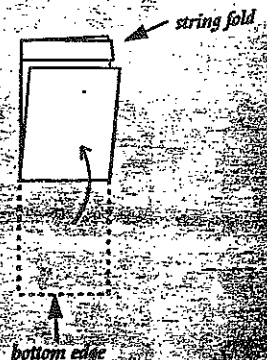

6

Fold the paper at an angle by placing the bottom folded edge along edge *a*.

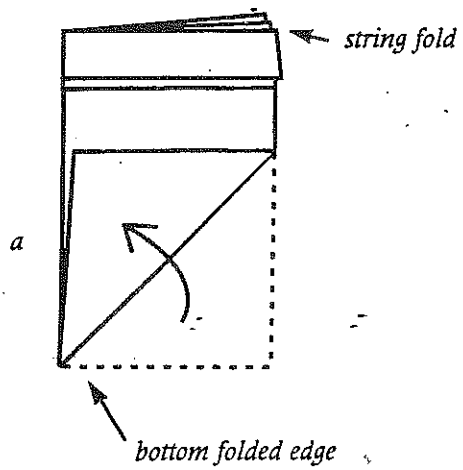

7

Cut the shapes shown along edge *a* and edge *b*. Do not cut corner *c* or cut above fold *d*. Remember not to cut shapes in the string fold.

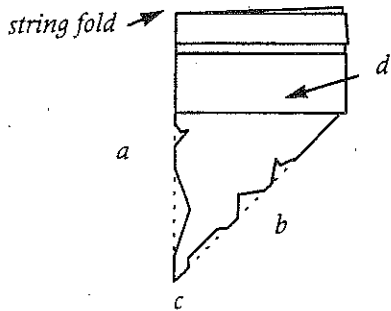

enlarged view

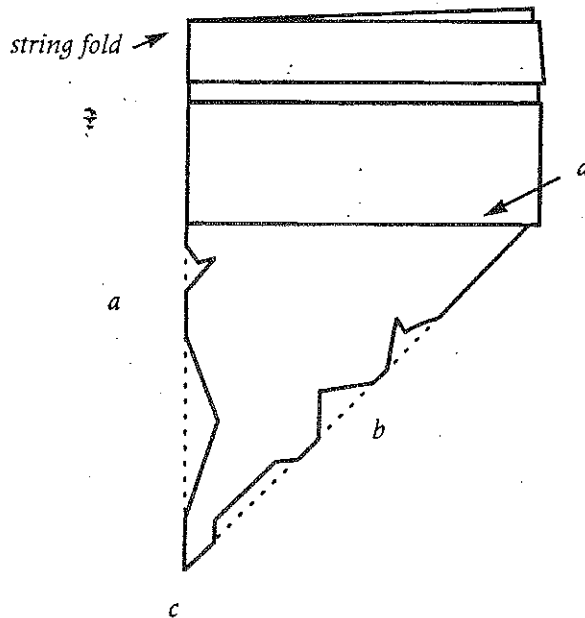



Carefully unfold the paper by reversing the folds to step 4. You can now make the cutout more interesting by trimming the bottom to complement your Twinkling Stars design. Cut the shapes shown here along the bottom edge. Carefully open the cutout by reversing the folds.



*bottom edge*

*enlarged view*

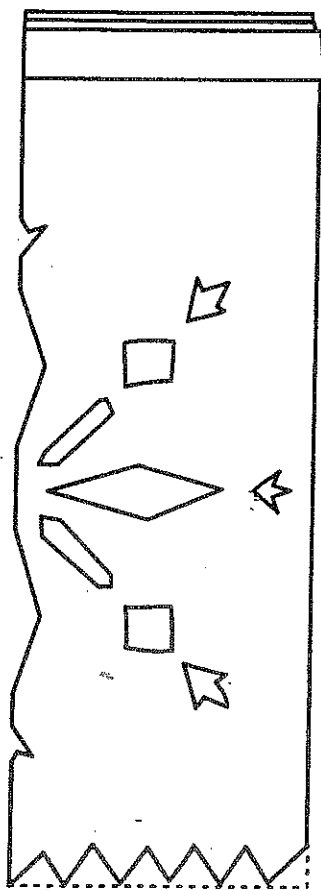

*bottom edge*